



# Quickie IRIS - SMD May 2019



EIZ4-2

**Mark For:**

Date: \_\_\_\_\_  
 Dealer Acct #: \_\_\_\_\_  
 Dealer: \_\_\_\_\_  
 Dealer Contact: \_\_\_\_\_  
 Dealer Address: \_\_\_\_\_  
 Dealer City: \_\_\_\_\_ PV: \_\_\_\_\_ PC: \_\_\_\_\_  
 Dealer Phone: ( ) \_\_\_\_\_ Fax: ( ) \_\_\_\_\_  
 Confirmation E-Mail: \_\_\_\_\_  
 Confirm Via:  Fax  E-Mail

**Submitting for:**

Quote  Order

PO#: \_\_\_\_\_

**ADDITIONAL SHIPPING INFORMATION**

Ship To: \_\_\_\_\_  
 Attention: \_\_\_\_\_  
 Address: \_\_\_\_\_  
 Address: \_\_\_\_\_  
 Ship To City: \_\_\_\_\_ PV: \_\_\_\_\_ PC: \_\_\_\_\_  
 Ship To Phone: ( ) \_\_\_\_\_ Fax: ( ) \_\_\_\_\_

✓	Option #	Definition	Price	✓	Option #	Definition	Price
---	----------	------------	-------	---	----------	------------	-------

**1. FRAME****Base Model**

<input type="checkbox"/>	183WM56	Quickie IRIS with True Fit Growth	
--------------------------	---------	-----------------------------------	--

**Pre-Set Tilt Angle (55° range) (Default in Bold)**

<input type="checkbox"/>	183TA5	-5 to 50° N/A w/ Heavy Duty and 12.5" STFH	
<input type="checkbox"/>	183TA6	<b>0 to 55°</b>	
<input type="checkbox"/>	183TA7	+5 to 60° N/A w/ Heavy Duty Package	

**Pre-Set Tilt Angle (40° range) (Default in Bold)**

<input type="checkbox"/>	183TA8	-5 to 35° N/A w/ Heavy Duty and 12.5" STFH	
<input type="checkbox"/>	183TA1	0 to 40°	
<input type="checkbox"/>	183TA10	<b>+5 to 45°</b> N/A w/ Heavy Duty Package	

**Tilt Release Options**

<input type="checkbox"/>	183TT12	Backrest Dual trigger cable releases	
--------------------------	---------	--------------------------------------	--

**Transit**

<input type="checkbox"/>	183TO45	WC-19 Transit Option	
--------------------------	---------	----------------------	--

**Frame Options**

<input type="checkbox"/>	183FS23	Standard Base and Seat Frame Maximum Weight: 300 lbs..	
<input type="checkbox"/>	183HV1	Heavy Duty Package (Max: 400 lbs..) NA w/ Vent, Battery Tray and Mono Back	
<input type="checkbox"/>	183FS24	Vent/Battery Tray Base NA w/ Attendant Wheel Lock, Mono Back and 14" and 15" frame width; min 17" STFH.	OTP
<input type="checkbox"/>	183FT46	Contracture Seat Frame NA w/ 14" or 15" frame depths. NA w/ drop seat pan.	J

**Frame Struts**

<input type="checkbox"/>	183GY01	Fixed (Standard)	
--------------------------	---------	------------------	--

**2. SIZE / SEATING****Frame Width**

21" & 22" not available with removable stroller handle extension

<input type="checkbox"/>	183W5	14"	
<input type="checkbox"/>	183W6	15"	
<input type="checkbox"/>	183W7	16"	
<input type="checkbox"/>	183W8	17"	
<input type="checkbox"/>	183W9	18"	
<input type="checkbox"/>	183W10	19"	
<input type="checkbox"/>	183W11	20"	
<input type="checkbox"/>	183W12	21"	
<input type="checkbox"/>	183W13	22"	

**Frame Width - Built 4 Me Options**

Requires Heavy Duty package

<input type="checkbox"/>	183W57	B4ME - 23" Width	
<input type="checkbox"/>	183W58	B4ME - 24" Width	

**Seat Type**

<input type="checkbox"/>	183ST35	Standard Seat Pan For growth ranges, see Figure 1.5	
--------------------------	---------	--	--

**A. Setup By QUICKIE**

**B. Setup By DEPTH**

**A. User's Seated Height**

See **Figure 1.1**, Dimension B. Distance from seat surface to top of the head.

<input type="checkbox"/>	183SJ01	Less than 37"	
<input type="checkbox"/>	183SJ02	37" or Greater	

**A. User's Weight (Default in Bold)**

301 lbs. - 400 lbs.. options only available w/ HD Package

<input type="checkbox"/>	183BO01	<b>0 lbs. - 300 lbs.</b>	
<input type="checkbox"/>	183BO03	301 lbs. - 350 lbs.	
<input type="checkbox"/>	183BO12	351 lbs. - 400 lbs.	

**A. Desired Seat Depth**

See **Figure 1.1**, Dimension A for measurement

<input type="checkbox"/>	183SD7	14"	
<input type="checkbox"/>	183SD8	15"	
<input type="checkbox"/>	183SD9	16"	
<input type="checkbox"/>	183SD10	17"	
<input type="checkbox"/>	183SD11	18"	
<input type="checkbox"/>	183SD12	19"	
<input type="checkbox"/>	183SD13	20"	
<input type="checkbox"/>	183SD14	21"	
<input type="checkbox"/>	183SD33	22"	

OR

**B. Frame Depth Range**

<input type="checkbox"/>	183FL91	Short Seat Frame 14"-18"	
<input type="checkbox"/>	183FL92	Medium Seat Frame 16"-20"	
<input type="checkbox"/>	183FL93	Long Seat Frame 18"-22"	

**B. Frame Depth**

<input type="checkbox"/>	183FD5	14" <i>recommend short seat frame</i>	
<input type="checkbox"/>	183FD6	15" <i>recommend short seat frame</i>	
<input type="checkbox"/>	183FD7	16" <i>recommend short seat frame</i>	
<input type="checkbox"/>	183FD8	17" <i>recommend short seat frame</i>	
<input type="checkbox"/>	183FD9	18" <i>recommend medium seat frame</i>	
<input type="checkbox"/>	183FD10	19" <i>recommend medium seat frame</i>	
<input type="checkbox"/>	183FD11	20" <i>recommend long seat frame</i>	
<input type="checkbox"/>	183FD16	21" <i>recommend long seat frame</i>	
<input type="checkbox"/>	183FD17	22" <i>recommend long seat frame</i>	

**A. Top of Cushion to Seat Rail**

See **FIGURE 1.2** Dimensions A & B. This measurement is taken from the top of the cushion to the upper surface of the seat rail. If the cushion has a wedged shape and/or has significant lateral pelvic contour, then determine the height of the cushion at the point where the ischial tuberosities would contact (not immerse) the cushion surface.

<input type="checkbox"/>	183CJ01	2 1/2" or Greater	
<input type="checkbox"/>	183CJ02	Less than 2 1/2"	
<input type="checkbox"/>	183CJ03	Below Seat Rail	

Desired Seat Depth

Figure 1.1

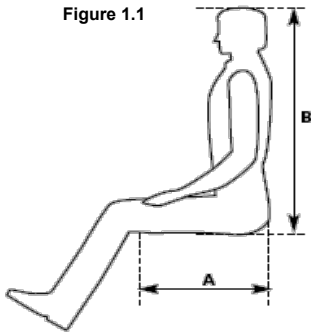

Figure 1.2

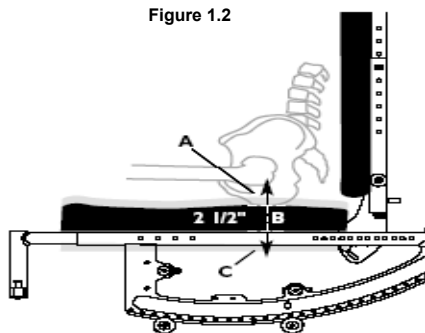

Figure 1.3

Frame Width	Seat Pan Growth
14"	14" - 16"
15"	15" - 16"
16"	16" - 18"
17"	17" - 18"
18"	18" - 20"
19"	19" - 20"
20"	20" - 22"
21"	21" - 22"
22"	NA

**3. CASTERS / SEAT HEIGHTS / REAR WHEELS**

**Front Seat Height**

Rear Wheel Size	CASTER SIZE					
	4"	5"	6"	8x1"	8x1.5"	8x2"
12" Mag	<input type="checkbox"/> 12.5"	<input type="checkbox"/> 13.5"	<input type="checkbox"/> 16.5"		<input type="checkbox"/> 16.5"	
		<input type="checkbox"/> 16.5"	<input type="checkbox"/> 17.0"	<input type="checkbox"/> 17.0"	<input type="checkbox"/> 17.0"	
		<input type="checkbox"/> 17.0"	<input type="checkbox"/> 17.5"	<input type="checkbox"/> 17.5"	<input type="checkbox"/> 17.5"	<input type="checkbox"/> 17.0"
		<input type="checkbox"/> 17.5"	<input type="checkbox"/> 18.0"	<input type="checkbox"/> 18.0"	<input type="checkbox"/> 18.0"	
12" Low Poly		<input type="checkbox"/> 16.0"	<input type="checkbox"/> 16.0"		<input type="checkbox"/> 16.0"	
		<input type="checkbox"/> 16.5"	<input type="checkbox"/> 16.5"	<input type="checkbox"/> 16.5"	<input type="checkbox"/> 16.5"	<input type="checkbox"/> 16.5"
		<input type="checkbox"/> 17.0"	<input type="checkbox"/> 17.0"	<input type="checkbox"/> 17.0"	<input type="checkbox"/> 17.0"	<input type="checkbox"/> 17.0"
		<input type="checkbox"/> 17.5"		<input type="checkbox"/> 17.5"		
22" Mag		<input type="checkbox"/> 17.0"	<input type="checkbox"/> 17.0"	<input type="checkbox"/> 17.0"		<input type="checkbox"/> 17.0"
		<input type="checkbox"/> 17.5"	<input type="checkbox"/> 17.5"	<input type="checkbox"/> 17.5"	<input type="checkbox"/> 17.5"	
		<input type="checkbox"/> 18.0"	<input type="checkbox"/> 18.0"	<input type="checkbox"/> 18.0"	<input type="checkbox"/> 18.0"	<input type="checkbox"/> 18.0"
		<input type="checkbox"/> 18.5"			<input type="checkbox"/> 18.5"	
24" Mag / 4 Spoke		<input type="checkbox"/> 18.0"	<input type="checkbox"/> 18.0"		<input type="checkbox"/> 18.0"	<input type="checkbox"/> 18.0"
		<input type="checkbox"/> 18.5"	<input type="checkbox"/> 18.5"	<input type="checkbox"/> 18.5"	<input type="checkbox"/> 18.5"	
			<input type="checkbox"/> 19.0"	<input type="checkbox"/> 19.0"	<input type="checkbox"/> 19.0"	<input type="checkbox"/> 19.0"
			<input type="checkbox"/> 19.5"			

**Castors**

<input type="checkbox"/> 183CW73	4" x 1.25" Semi Pneumatic N/A w/ Heavy Duty Option	J
<input type="checkbox"/> 183CW53	5" x 1" Polyurethane	
<input type="checkbox"/> 183CW7	5" x 1.5" Semi Pneumatic	OTP
<input type="checkbox"/> 183CW45	6" x 1" Polyurethane	
<input type="checkbox"/> 183CW35	6" x 1.5" Semi Pneumatic	
<input type="checkbox"/> 183CW46	8" x 1" Polyurethane	
<input type="checkbox"/> 183CW39	8"x 1.5" Semi Pneumatic	
<input type="checkbox"/> 183CW36	8"x 2" Pneumatic	J
<input type="checkbox"/> 183CW37	8"x 2" Pneumatic w/Insert	J

**Axle Plate**

One arm drive only available in 6 spoke Mags

<input type="checkbox"/> 183AL33	Standard Axle Plate	
<input type="checkbox"/> 183AL17	One Arm Drive Axle Plate N/A w/ 12" & 16" mag, 24" spoke wheels.	J
<input type="checkbox"/> 183OA2	One Arm Drive Standard Handrim	J
<input type="checkbox"/> 183HM1	Right Hand Mount	
<input type="checkbox"/> 183HM2	Left Hand Mount	
<input type="checkbox"/> 183OA1	One Arm Drive Small Handrim N/A w/ 20" mag wheels	J
<input type="checkbox"/> 183HM1	Right Hand Mount	
<input type="checkbox"/> 183HM2	Left Hand Mount	

**4. WHEEL LOCKS / HUB LOCK**

**Wheel Lock**

<input type="checkbox"/> 183WL8	Push to Lock	
<input type="checkbox"/> 183WL41	Attendant Wheel Lock (Foot Lock) N/A w/ ext handles. N/A w/ one arm drive	
<input type="checkbox"/> 183WL10	Omit Wheel Lock	J

**Rear Wheel**

12"-16" N/A w/handrims. 12" w/attendant wheel lock N/A w/ +5 - 60° tilt angle.  
20"-22" Mag wheel N/A w/Projection handrims. See matrix for availability

<input type="checkbox"/> 183RW13	12" Mag Wheel	
<input type="checkbox"/> 183RW8	22" Mag Wheel	
<input type="checkbox"/> 183RW1	24" Mag Wheel	
<input type="checkbox"/> 183RW51	24" Spoke Wheel	

**Rear Tire & Wheel Matrix**

Tire	Rear Wheel		
	5 Spoke Mag	Spoke	Mag Wheel
Pneumatic	20,22,24	24	12,16,20,22,24
Pneumatic w/ Airless Insert	20,22,24	24	12,16,20,22,24
Full Poly	20,22,24	24	20,22,24
Low Poly	NA	NA	12

12" = 203mm 16" = 305mm 20" = 451mm 22" = 501mm 24" = 540mm

**Rear Wheel Tire**

<input type="checkbox"/> 183RT3	Full Polyurethane	
<input type="checkbox"/> 183RT4	Low Polyurethane	
<input type="checkbox"/> 183RT1	Pneumatic	J
<input type="checkbox"/> 183RT2	Pneumatic Airless Insert	

**Handrim**

12" and 16" wheels not available with hand rims. See matrix for availability

<input type="checkbox"/> 183HR1	Aluminum Anodized	
<input type="checkbox"/> 183HR4	Plastic Coated	J
<input type="checkbox"/> 183HR7	Omit Handrim	

**Rear Wheel & Handrim Matrix**

Handrim	Rear Wheel		
	5 Spoke Mag	Spoke	Mag Wheel
Aluminum Anodized	20,22,24	24	20,22,24
Plastic Coat	20,22,24	24	20,22,24
Projection 8 Oblique	NA	NA	24

**Projections**

Not available on plastic coated. Only available with 24" rim MAG wheels

<input type="checkbox"/> 183HR8	8 Oblique	
---------------------------------	-----------	--

**Axle**

<input type="checkbox"/> 183AX1	Quick Release Axles N/A w/ one arm drive	
<input type="checkbox"/> 183AX17	Threaded Axles N/A w/ 24" spoke wheels	

**Extension Handle**

<input type="checkbox"/> 183EH7	6" Pair	
---------------------------------	---------	--

**5. HANGER AND FOOTREST**

**Footrest (Choose ONE Option - A, B, or C)**

<b>A. Hanger Mounted Footrest</b>			
<input type="checkbox"/>	183H140	70° Swing In/Swing Out -Front Mount	
<input type="checkbox"/>	183H142	80° Swing In/Swing Out -Front Mount	
<input type="checkbox"/>	183H158	90° Swing In/Swing Out -Front Mount	
<input type="checkbox"/>	183H146	70° Heavy Duty Front Mount Lift Off	
<input type="checkbox"/>	183H132	80° Heavy Duty Front Mount Lift Off N/A w/ 4" casters	
<input type="checkbox"/>	183H147	90° Heavy Duty Front Mount Lift Off N/A w/ 4" casters	
<input type="checkbox"/>	183H161	Elevating Hanger - Front Mount N/A 90° footboard, some interference with casters if not tilted, 17" wide chairs & up.	J

**A**

<b>A. Hanger Mounted Footrest Extension Tubes</b>			
N/A w/ 12.5" seat height			
<input type="checkbox"/>	183E23	2" N/A w/ 90 swing away, 90 lift off hangers	
<input type="checkbox"/>	183E24	4" N/A w/ 90 swing away, 90 lift off hangers	

<b>A. Hanger Mounted Footrest Footplates</b>			
Heel loop or leg strap not included. See Footplate Options Section			
<input type="checkbox"/>	183F4	Kids Angle Adj Available w/ 14" to 16" frame width only	J
<input type="checkbox"/>	183F8	Adult Angle Adj - Front Mount	J
<input type="checkbox"/>	183A7	Omit Footplate	J

<b>B. Extension Tube Mounted Footrests</b>			
Footrests mount to extension tubes			
<input type="checkbox"/>	183H145	60° Swing In/Swing Out	
<input type="checkbox"/>	183H139	70° Swing In/Swing Out	
<input type="checkbox"/>	183H141	80° Swing In/Swing Out N/A w/ 8" casters	
<input type="checkbox"/>	183H160	Elevating Hanger - Ext Mount N/A w/ Platform Flip Up and Alum Angle Adj Front Mount footplates.	J
<input type="checkbox"/>	183H159	Articulating Hanger N/A w/ Platform Flip Up and Alum Angle Adj Front Mount footplates.	OTP

**B**

<b>B. Extension Tube Mounted Footrests</b>			
<input type="checkbox"/>	183E1	Short	
<input type="checkbox"/>	183E2	Medium N/A with 12.5" seat height	
<input type="checkbox"/>	183E5	Long N/A with 12.5" seat height	
<input type="checkbox"/>	183E16	High Mount Only available with adult or kids angle adj. footplates	

<b>B. Extension Tube Mounted Footrest Footplates</b>			
Heel loop or leg strap not included. See Footplate Options Section			
<input type="checkbox"/>	183F1	Composite	
<input type="checkbox"/>	183F5	Aluminum Only available w/ELR	
<input type="checkbox"/>	183F3	Adult Angle Adjustable - Ext Mount	J
<input type="checkbox"/>	183F48	Platform Flip-Up N/A w/ med ext tubes.	OTP
<input type="checkbox"/>	183F7	Omit Footplate and Ext. Tube	J

<b>OR</b>			
<b>C. Contracture Footrest System</b>			
Multi-Adjustable Padded Hangers & Angle Adjustable Aluminum Footrests			
<input type="checkbox"/>	183H26	Contracture Footrest System N/A w/ drop seat pan. N/A w/ 15" frame depth	
<input type="checkbox"/>	183FP02	Outside Mount	
<input type="checkbox"/>	183FP01	Center Mount	
Select Extension Height Below for Short			
<input type="checkbox"/>	183E25	Short	
<input type="checkbox"/>	183EP1	10.5" Extension Height	
<input type="checkbox"/>	183EP2	11.0" Extension Height	
<input type="checkbox"/>	183EP3	11.5" Extension Height	
<input type="checkbox"/>	183EP4	12.0" Extension Height	
<input type="checkbox"/>	183EP5	12.5" Extension Height	
<input type="checkbox"/>	183EP6	13.0" Extension Height	
Select Extension Height Below for Regular			
<input type="checkbox"/>	183E26	Regular	
<input type="checkbox"/>	183EP5	12.5" Extension Height	
<input type="checkbox"/>	183EP6	13.0" Extension Height	
<input type="checkbox"/>	183EP7	13.5" Extension Height	
<input type="checkbox"/>	183EP8	14.0" Extension Height	
<input type="checkbox"/>	183EP9	14.5" Extension Height	
<input type="checkbox"/>	183EP10	15.0" Extension Height	

**C**

<b>OR</b>			

**D**

<b>Additional Hanger and Footplate Options</b>			
<b>Hanger Mounts</b>			
1" Offset N/A with -5-50° and -5-35° preset tilt angle and possible interference with 80° & 90° hangers			
<input type="checkbox"/>	183MZ02	Standard Hanger Mount	
<input type="checkbox"/>	183MZ01	1" Offset Hanger Mount	
<b>Footrest Options</b>			
<input type="checkbox"/>	183HL1	Heel Loop	
<input type="checkbox"/>	183IG2	Impact Guard Neoprene Only available w/ 60° or 70° ext. mount hanger	OTP
<input type="checkbox"/>	183H32	Omit Hanger	
<input type="checkbox"/>	183HL4	Omit Heel Loop	

Option #	Definition	Price	Option #	Definition	Price
----------	------------	-------	----------	------------	-------

**5. HANGER AND FOOTREST (CONT)**

**JAY FOOT BOXES**

Only available with Swing Away, Lift-off Hangers, Adult Angle Adj Footplates and ELR / ALR. Single Foot Box pairs N/A with 14"-15" frame widths. Full Foot Boxes N/A with Heel Loop or Leg Strap, Tall Height Full Footbox w/ 14"-15" frame width and ELR / ALR. Full Foot Box not available with 23"-24" widths.

**Single Foot Box**

<input type="checkbox"/>	183JX01	Standard Height - Left	OTP
<input type="checkbox"/>	183JX02	Tall Height - Left	OTP
<input type="checkbox"/>	183JX03	Standard Height - Right	OTP
<input type="checkbox"/>	183JX04	Tall Height - Right	OTP

**JAY FOOT BOXES (cont)**

<input type="checkbox"/>	183JX05	Standard Height - Pair	OTP
<input type="checkbox"/>	183JX06	Tall Height - Pair	OTP
<b>OR</b>			
<b>Full Foot Box</b>			
<input type="checkbox"/>	183JX07	Full Foot box Std Height	OTP
<input type="checkbox"/>	183JX08	Full Foot box Tall Height	OTP
<input type="checkbox"/>	183JX09	Full Foot box w/ Divider Std Ht	OTP
<input type="checkbox"/>	183JX10	Full Foot box w/ Divider Tall Ht	OTP

**6. BACKREST / SEATING**

**Dynamic Backrest**

<input type="checkbox"/>	183BT101	Dynamic Backrest N/A w/ Reclining Backrest or 22" seat depth. N/A w/ Heavy D.	21"	OTP
--------------------------	----------	---	-----	-----

**Backpost Style - (Choose ONE Option - A, B, C, or D)**

**A. Stroller Handle Backpost (Fixed)**

<input type="checkbox"/>	183BP9	Low (18")	A
<input type="checkbox"/>	183BP10	Medium (21")	
<input type="checkbox"/>	183BP11	Tall (24")	
<input type="checkbox"/>	183BP13	Removable Extension N/A w/ 21"-22" frame width, height adj back with adj stroller handles	

**OR**

**B. Height Adjustable Back w/ Adj. Stroller Handles**

Select desired Push Handle

<input type="checkbox"/>	183PH8	Standard Push Handle	B
<input type="checkbox"/>	183PH9	Long Push Handle Recommended in combo w/ vent & battery tray	

AND select desired Back Cane

<input type="checkbox"/>	183B200	Standard 15"-21"
<input type="checkbox"/>	183B201	Tall 18"-24"

**OR**

**C. Reclining Backrest (0-40°)**

Only available with 40 degree tilt range. N/A w/ 22" Deep Frame.

<input type="checkbox"/>	183BT21	Reclining Backrest	J
<input type="checkbox"/>	183B5	Medium	J
<input type="checkbox"/>	183B9	Tall	J
<input type="checkbox"/>	183BP64	Angle Adj stroller handles Height adj range 19"- 23"	J
<input type="checkbox"/>	183PH8	Standard push handle	J
<input type="checkbox"/>	183PH9	Long push handle	J

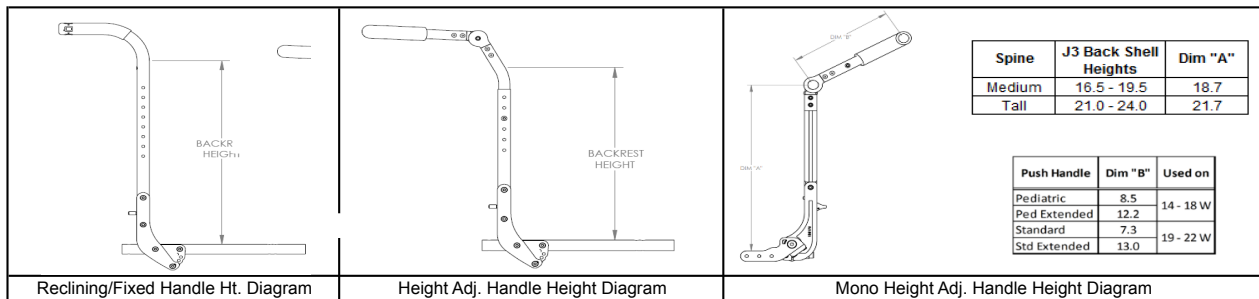

**Backrest Position (set up by Quickie)**

See FIGURE 1.5. The location of the backrest surface in relation to the front of the backpost. The measurement is taken from the front surface of the backpost to the deepest area of the backrest in contact with the user's body.

<input type="checkbox"/>	183BQ01	+3"
<input type="checkbox"/>	183BQ05	+2"
<input type="checkbox"/>	183BQ02	+1"
<input type="checkbox"/>	183BQ03	Flush
<input type="checkbox"/>	183BQ04	-1"
<input type="checkbox"/>	183BQ06	-2"

Figure 1.5

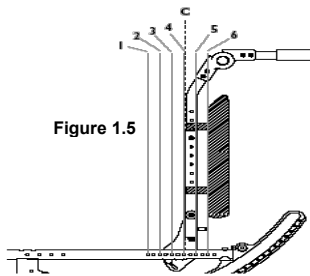

**Back Type**

1	3" forward (+3')
2	2" forward (+2')
3	1" forward (+1')
4	Flush
5	1" rearward (-1')
6	2" rearward (-2')

**6. BACKREST / SEATING (CONT)**



**7. ARMREST / SIDE GUARDS**

**Armrest**

*Heavy Duty Option only available w/ Dual Post Armrest*

<input type="checkbox"/>	183AA63	Dual Post Height Adjustable	
<input type="checkbox"/>	183AA43	Dual Post Flip Back	
<input type="checkbox"/>	183AA62	Dual Post	
<input type="checkbox"/>	183AA48	Dual Post Flip Back Height Adj	
<input type="checkbox"/>	183AA11	Single Post Height Adjustable - Std	
<input type="checkbox"/>	183AA29	Single Post Height Adjustable - Low	



<input type="checkbox"/>	183AA14	Omit Armrest	J
--------------------------	---------	--------------	---

**Armrest Receiver (Single Post Height Adjustable Only)**

<input type="checkbox"/>	183AR17	Low	
<input type="checkbox"/>	183AR18	Std	

**Ampad**

*Ergo ampad only available with Single post Height adj armrest*

<input type="checkbox"/>	183AM23	Desk Length Classic	
<input type="checkbox"/>	183AM21	Desk Length Contour	
<input type="checkbox"/>	183AM24	Full Length Classic	
<input type="checkbox"/>	183AM22	Full Length Contour	



**Side Guard**

*Only available w/ length adj locking flip-up, adj locking flip-up and armrest styles. N/A w/ Mono Back.*

<input type="checkbox"/>	183SG3	Plastic Regular	OTP
<input type="checkbox"/>	183SG4	Plastic Kids	OTP

**7. ARMREST / SIDE GUARDS (CONT)**



Armrest Matrix for Single Post					
Armrest Size	Transfer Tube Length D	Receiver	Classic Pad		
			H Range	Pad length L	
				Desk	Full
Std	8"	Std	10-3/4" to 15-3/4"	10-1/4"	14"
		Low	8-3/4" to 13-3/4"		
Low	5-1/4"	Std	9" to 13"	10-1/4"	14"
		Low	7-1/4" to 11-1/4"		
Contour Pad					
Receiver	H Range	Pad length L			
		Desk	Full		
Std	10" to 15"	10-1/2"	14-1/4"		
Low	8-1/4" to 13-1/4"				
Std	8-1/2" to 12-1/2"				
Low	6-3/4" to 10-3/4"				
Ergo Pad					
Receiver	H Range	Pad length L			
		11-3/4"			
Std	10-1/2" to 15-1/2"				
Low	8-3/4" to 13-3/4"				
Std	9" to 13"				
Low	7-1/4" to 11-1/4"				

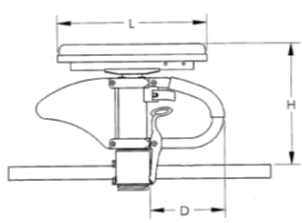

**8. KEY OPTIONS AND ACCESSORIES**

**Anti Tips**

Included with vent tray option. Not ordered as separate line item.

183AT1 Anti Tips (Pair)

**Positioning Belt**

Add: 1.5" Auto Buckle

**Spoke Guards**

Not available with 12" and 16" mag wheels or projection handrims.

183A24 Clear OTP

183A23 Black N/A w/ projection handrims OTP

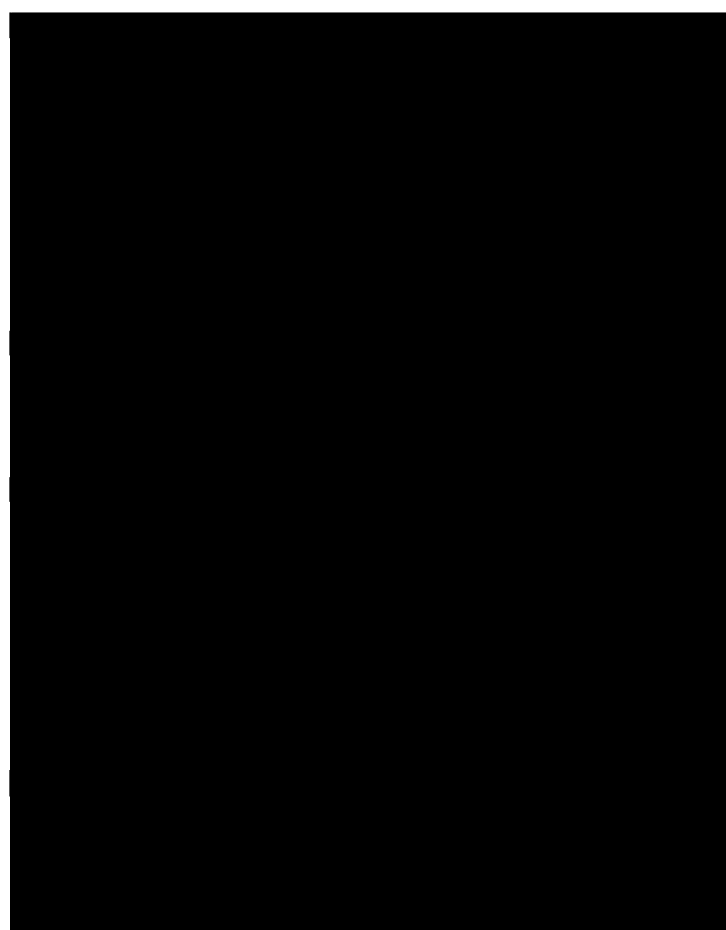
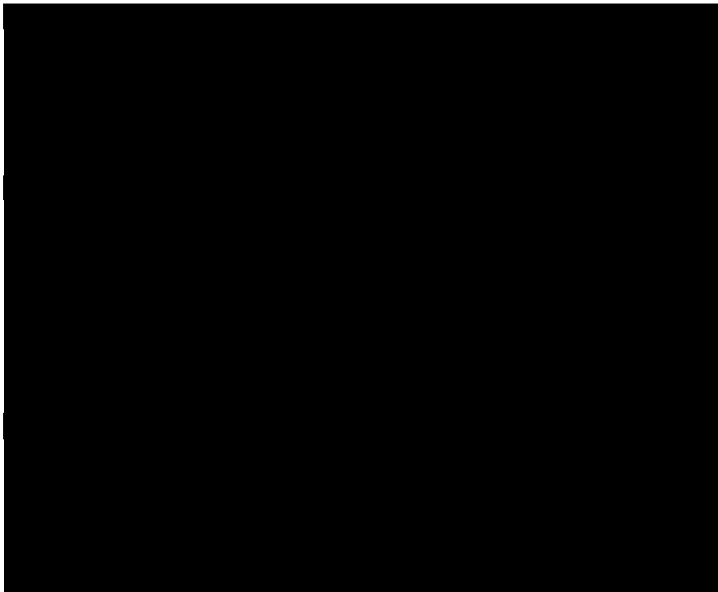

**Headrests**

PIL Whitmyer Headrest

M2300 Bracket

Standard Frame Color	
<input type="checkbox"/>	183C2 Black



- Commonly Requested Options Include:**
- ✓ Frog Legs
  - ✓ Longer Wheel Lock Extensions
  - ✓ Reverse Configuration
  - ✓ Dual Mount Wheel Locks - Attendant Foot Lock
  - ✓ Dynamic Back on Frame Depth up to 20"
  - ✓ 23" & 24" Seat Widths

**10. APPENDIX**

**Lower Leg Length Matrix**

Front seat height must be at least 2" taller than lower leg length on all swing in/out hangers. Front seat height must be at least 2" taller than maximum lower leg length on all front mount hangers.

Hanger	Extension	Seat Pan to Top of Footrest		Min Allowable FSH
		Min	Max	
70° Front Mount	No Ext	3 1/2	9	11 1/2
	2"	3 1/2	11 1/2	13 1/2
	4"	3 1/2	13 1/2	15 1/2
80° Front Mount	No Ext	3 1/2	9 1/2	11 1/2
	2"	3 1/2	12	14
	4"	3 1/2	14	16
90° Front Mount	No Ext	3	9	11 1/2
ELR Front Mount	No Ext	3	7	10 1/2
60° Swing In/Out	Short	9	12 1/2	12 1/2
	Med	9	14 1/2	12 1/2
	Long	11 1/2	16	14 1/2
70° Swing In/Out	Short	10 1/2	15 1/2	12 1/2
	Med	10 1/2	17 1/2	13
	Long	13 1/2	19	15
80° Swing In/Out	Short	11	14 1/2	13
	Med	11	16 1/2	13
	Long	13	18	15
ALR	Short	8 1/2	15	10 1/2
	Med	10	17	12
	Long	12	19	14
ELR Ext. Mount	Short	8	14 1/2	10
	Medium	9 1/2	16 1/2	11 1/2
	Long	11 1/2	18 1/2	13 1/2

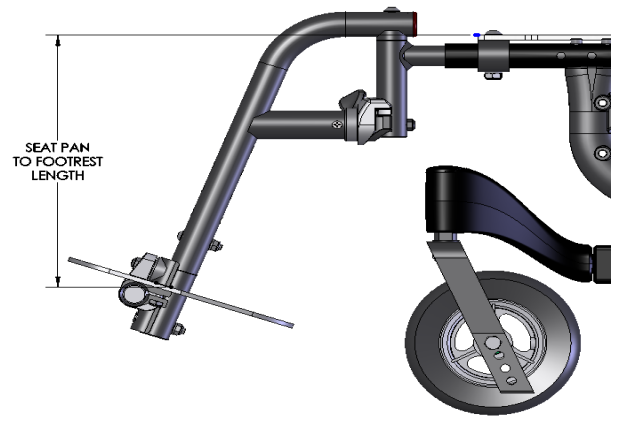





**JAY® Signature Series Backrest and Accessories**  
 Note: Not all sizes and configurations shown below, for full offering visit [www.sunrisemedical.ca](http://www.sunrisemedical.ca)

When ordering mark the part number desired and it will be added to the order as a separate line item .

**JAY BACKREST**

JAY J3 Back PA (2.2" Contour Depth)			JAY J3 Back PL (3" Contour Depth)		
<i>MT Shells- 4 Point Standard Hardware</i>			<i>MT Shells- 4 Point Standard Hardware</i>		
<input type="checkbox"/>	J3PAMTT12FS	12" Wide J3 Back w/ 15" Shell Height	<input type="checkbox"/>	J3PLMTT12FS	12" Wide J3 Back w/ 15" Shell Height
<input type="checkbox"/>	J3PAMTT14FS	14" Wide J3 Back w/ 15" Shell Height	<input type="checkbox"/>	J3PLMTT14FS	14" Wide J3 Back w/ 15" Shell Height
<input type="checkbox"/>	J3PAMTT16FS	16" Wide J3 Back w/ 15" Shell Height	<input type="checkbox"/>	J3PLMTT16FS	16" Wide J3 Back w/ 15" Shell Height
<input type="checkbox"/>	J3PAMTT18FS	18" Wide J3 Back w/ 15" Shell Height	<input type="checkbox"/>	J3PLMTT18FS	18" Wide J3 Back w/ 15" Shell Height
<input type="checkbox"/>	J3PAMTT20FS	20" Wide J3 Back w/ 15" Shell Height	<input type="checkbox"/>	J3PLMTT20FS	20" Wide J3 Back w/ 15" Shell Height
<i>UT Shells- 4 Point Standard Hardware</i>			<i>UT Shells- 4 Point Standard Hardware</i>		
<input type="checkbox"/>	J3PAUTS12FS	12" Wide J3 Back w/ 16.5" Shell Height	<input type="checkbox"/>	J3PLUTS12FS	12" Wide J3 Back w/ 16.5" Shell Height
<input type="checkbox"/>	J3PAUTS14FS	14" Wide J3 Back w/ 16.5" Shell Height	<input type="checkbox"/>	J3PLUTS14FS	14" Wide J3 Back w/ 16.5" Shell Height
<input type="checkbox"/>	J3PAUTS16FS	16" Wide J3 Back w/ 16.5" Shell Height	<input type="checkbox"/>	J3PLUTS16FS	16" Wide J3 Back w/ 16.5" Shell Height
<input type="checkbox"/>	J3PAUTS18FS	18" Wide J3 Back w/ 16.5" Shell Height	<input type="checkbox"/>	J3PLUTS18FS	18" Wide J3 Back w/ 16.5" Shell Height
<input type="checkbox"/>	J3PAUTS20FS	20" Wide J3 Back w/ 16.5" Shell Height	<input type="checkbox"/>	J3PLUTS20FS	20" Wide J3 Back w/ 16.5" Shell Height
<input type="checkbox"/>	J3PAUTM14FS	14" Wide J3 Back w/ 18" Shell Height	<input type="checkbox"/>	J3PLUTM14FS	14" Wide J3 Back w/ 18" Shell Height
<input type="checkbox"/>	J3PAUTM16FS	16" Wide J3 Back w/ 18" Shell Height	<input type="checkbox"/>	J3PLUTM16FS	16" Wide J3 Back w/ 18" Shell Height
<input type="checkbox"/>	J3PAUTM18FS	18" Wide J3 Back w/ 18" Shell Height	<input type="checkbox"/>	J3PLUTM18FS	18" Wide J3 Back w/ 18" Shell Height
<input type="checkbox"/>	J3PAUTM20FS	20" Wide J3 Back w/ 18" Shell Height	<input type="checkbox"/>	J3PLUTM20FS	20" Wide J3 Back w/ 18" Shell Height
<input type="checkbox"/>	J3PAUTM22FS	22" Wide J3 Back w/ 18" Shell Height	<input type="checkbox"/>	J3PLUTT14FS	14" Wide J3 Back w/ 19.5" Shell Height
<input type="checkbox"/>	J3PAUTT14FS	14" Wide J3 Back w/ 19.5" Shell Height	<input type="checkbox"/>	J3PLUTT16FS	16" Wide J3 Back w/ 19.5" Shell Height
<input type="checkbox"/>	J3PAUTT16FS	16" Wide J3 Back w/ 19.5" Shell Height	<input type="checkbox"/>	J3PLUTT18FS	18" Wide J3 Back w/ 19.5" Shell Height
<input type="checkbox"/>	J3PAUTT18FS	18" Wide J3 Back w/ 19.5" Shell Height	<input type="checkbox"/>	J3PLUTT20FS	20" Wide J3 Back w/ 19.5" Shell Height
<input type="checkbox"/>	J3PAUTT20FS	20" Wide J3 Back w/ 19.5" Shell Height	<i>SH Shells- 4 Point Standard Hardware</i>		
<i>SH Shells- 4 Point Standard Hardware</i>			<input type="checkbox"/>	J3PLSHS14FS	14" Wide J3 Back w/ 21" Shell Height
<input type="checkbox"/>	J3PASHS14FS	14" Wide J3 Back w/ 21" Shell Height	<input type="checkbox"/>	J3PLSHS16FS	16" Wide J3 Back w/ 21" Shell Height
<input type="checkbox"/>	J3PASHS16FS	16" Wide J3 Back w/ 21" Shell Height	<input type="checkbox"/>	J3PLSHS18FS	18" Wide J3 Back w/ 21" Shell Height
<input type="checkbox"/>	J3PASHS18FS	18" Wide J3 Back w/ 21" Shell Height	<input type="checkbox"/>	J3PLSHS20FS	20" Wide J3 Back w/ 21" Shell Height
<input type="checkbox"/>	J3PASHS20FS	20" Wide J3 Back w/ 21" Shell Height	<input type="checkbox"/>	J3PLSHM16FS	16" Wide J3 Back w/ 22.5" Shell Height
<input type="checkbox"/>	J3PASHS22FS	22" Wide J3 Back w/ 21" Shell Height	<input type="checkbox"/>	J3PLSHM18FS	18" Wide J3 Back w/ 22.5" Shell Height
<input type="checkbox"/>	J3PASHM16FS	16" Wide J3 Back w/ 22.5" Shell Height	<input type="checkbox"/>	J3PLSHM20FS	20" Wide J3 Back w/ 22.5" Shell Height
<input type="checkbox"/>	J3PASHM18FS	18" Wide J3 Back w/ 22.5" Shell Height	<input type="checkbox"/>	J3PLSHT18FS	18" Wide J3 Back w/ 24" Shell Height
<input type="checkbox"/>	J3PASHM20FS	20" Wide J3 Back w/ 22.5" Shell Height	<input type="checkbox"/>	J3PLSHT20FS	20" Wide J3 Back w/ 24" Shell Height
<input type="checkbox"/>	J3PASHT18FS	18" Wide J3 Back w/ 24" Shell Height			
<input type="checkbox"/>	J3PASHT20FS	20" Wide J3 Back w/ 24" Shell Height			

JAY J3 Back PD (6" Contour Depth)			JAY J3 Back PL (3" Contour Depth)		
<i>MT Shells- 4 Point Standard Hardware</i>			<i>MT Shells- 4 Point Standard Hardware</i>		
<input type="checkbox"/>	J3PDMTT14FS	14" Wide J3 Back w/ 15" Shell Height	<input type="checkbox"/>	J3PLMTT12FS	12" Wide J3 Back w/ 15" Shell Height
<input type="checkbox"/>	J3PDMTT16FS	16" Wide J3 Back w/ 15" Shell Height	<input type="checkbox"/>	J3PLMTT14FS	14" Wide J3 Back w/ 15" Shell Height
<input type="checkbox"/>	J3PDMTT18FS	18" Wide J3 Back w/ 15" Shell Height	<input type="checkbox"/>	J3PLMTT16FS	16" Wide J3 Back w/ 15" Shell Height
<input type="checkbox"/>	J3PDMTT20FS	20" Wide J3 Back w/ 15" Shell Height	<input type="checkbox"/>	J3PLMTT18FS	18" Wide J3 Back w/ 15" Shell Height
<i>UT Shells- 4 Point Standard Hardware</i>			<i>UT Shells- 4 Point Standard Hardware</i>		
<input type="checkbox"/>	J3PDUTM14FS	14" Wide J3 Back w/ 18" Shell Height	<input type="checkbox"/>	J3PLUTS12FS	12" Wide J3 Back w/ 16.5" Shell Height
<input type="checkbox"/>	J3PDUTM16FS	16" Wide J3 Back w/ 18" Shell Height	<input type="checkbox"/>	J3PLUTS14FS	14" Wide J3 Back w/ 16.5" Shell Height
			<input type="checkbox"/>	J3PLUTS16FS	16" Wide J3 Back w/ 16.5" Shell Height
			<input type="checkbox"/>	J3PLUTS18FS	18" Wide J3 Back w/ 16.5" Shell Height
			<input type="checkbox"/>	J3PLUTS20FS	20" Wide J3 Back w/ 16.5" Shell Height
			<input type="checkbox"/>	J3PLUTM14FS	14" Wide J3 Back w/ 18" Shell Height
			<input type="checkbox"/>	J3PLUTM16FS	16" Wide J3 Back w/ 18" Shell Height
			<input type="checkbox"/>	J3PLUTM18FS	18" Wide J3 Back w/ 18" Shell Height
			<input type="checkbox"/>	J3PLUTM20FS	20" Wide J3 Back w/ 18" Shell Height

JAY J3 Back Headrest			JAY J3 Back PL (3" Contour Depth)		
<i>AXYS Mount and Pad</i>			<i>LINX Mount and Pad</i>		
<input type="checkbox"/>	J3HEDX8	AXYS Headrest with 8" Plush Pad	<input type="checkbox"/>	J3HEDL8	LINX Headrest with 8" Plush Pad
<input type="checkbox"/>	J3HEDX10	AXYS Headrest with 10" Plush Pad	<input type="checkbox"/>	J3HEDL10	LINX Headrest with 10" Plush Pad
<input type="checkbox"/>	J3HEDX14	AXYS Headrest with 14" Plush Pad	<input type="checkbox"/>	J3HEDL14	LINX Headrest with 14" Plush Pad
<input type="checkbox"/>	J3HEDXAAPN	AXYS with Adj-a-Plush Narrow Pad	<input type="checkbox"/>	J3HEDLAAPN	LINX with Adj-a-Plush Narrow Pad
<input type="checkbox"/>	J3HEDXAAPS	AXYS with Adj-a-Plush Std Pad	<input type="checkbox"/>	J3HEDLAAPS	LINX with Adj-a-Plush Std Pad

JAY J3 Back Laterals Swing Away Laterals With Pad - Pair			JAY J3 Back PL (3" Contour Depth)		
<input type="checkbox"/>	J3LAT4X4SA	SwingAway Lat with 4"x4" Pad (PR)	<input type="checkbox"/>	J3LAT6X4SA	SwingAway Lat with 6"x4" Pad (PR)
<input type="checkbox"/>	J3LAT4X5SA	SwingAway Lat with 4"x5" Pad (PR)	<input type="checkbox"/>	J3LAT6X5SA	SwingAway Lat with 6"x5" Pad (PR)
<input type="checkbox"/>	J3LAT4X6SA	SwingAway Lat with 4"x6" Pad (PR)	<input type="checkbox"/>	J3LAT6X6SA	SwingAway Lat with 6"x6" Pad (PR)



## JAY<sup>®</sup> Signature Series Cushions

Note: Not all sizes and configurations shown below, for full offering visit [www.sunrisemedical.ca](http://www.sunrisemedical.ca).  
When ordering mark the part number desired and it will be added to the order as a separate line item.

### JAY CUSHIONS

JAY Fusion Cushion		
<input type="checkbox"/>	JFUSION1416	JAY Fusion 14" x 16"
<input type="checkbox"/>	JFUSION1616	JAY Fusion 16" x 16"
<input type="checkbox"/>	JFUSION1618	JAY Fusion 16" x 18"
<input type="checkbox"/>	JFUSION1620	JAY Fusion 16" x 20"
<input type="checkbox"/>	JFUSION1717	JAY Fusion 17" x 17"
<input type="checkbox"/>	JFUSION1816	JAY Fusion 18" x 16"
<input type="checkbox"/>	JFUSION1818	JAY Fusion 18" x 18"
<input type="checkbox"/>	JFUSION1820	JAY Fusion 18" x 20"
<input type="checkbox"/>	JFUSION2018	JAY Fusion 20" x 18"
<input type="checkbox"/>	JFUSION2020	JAY Fusion 20" x 20"
<input type="checkbox"/>	JFUSION2220	JAY Fusion 22" x 20"

JAY J2 Cushion		
<input type="checkbox"/>	2108-MJ	JAY J2 14" x 16"
<input type="checkbox"/>	2105-MJ	JAY J2 15.5" x 16"
<input type="checkbox"/>	2106-MJ	JAY J2 15.5" x 18"
<input type="checkbox"/>	2107-MJ	JAY J2 15.5" x 20"
<input type="checkbox"/>	2117-MJ	JAY J2 17" x 17"
<input type="checkbox"/>	2100-MJ	JAY J2 18" x 16"
<input type="checkbox"/>	2101	JAY J2 18" x 18"
<input type="checkbox"/>	2103-MJ	JAY J2 18" x 20"
<input type="checkbox"/>	2118-MJ	JAY J2 20" x 18"
<input type="checkbox"/>	2102-MJ	JAY J2 20" x 20"

JAY Fusion Cushion w/ ROHO Single Valve Air Insert		
<input type="checkbox"/>	JFUSION1416AS	JAY Fusion 14" x 16"
<input type="checkbox"/>	JFUSION1616AS	JAY Fusion 16" x 16"
<input type="checkbox"/>	JFUSION1618AS	JAY Fusion 16" x 18"
<input type="checkbox"/>	JFUSION1620AS	JAY Fusion 16" x 20"
<input type="checkbox"/>	JFUSION1717AS	JAY Fusion 17" x 17"
<input type="checkbox"/>	JFUSION1816AS	JAY Fusion 18" x 16"
<input type="checkbox"/>	JFUSION1818AS	JAY Fusion 18" x 18"
<input type="checkbox"/>	JFUSION1820AS	JAY Fusion 18" x 20"
<input type="checkbox"/>	JFUSION2018AS	JAY Fusion 20" x 18"
<input type="checkbox"/>	JFUSION2020AS	JAY Fusion 20" x 20"
<input type="checkbox"/>	JFUSION2220AS	JAY Fusion 22" x 20"

JAY J2 Deep Contour Cushion		
<input type="checkbox"/>	2446	JAY J2 Deep Contour 14" x 16"
<input type="checkbox"/>	2466	JAY J2 Deep Contour 16" x 16"
<input type="checkbox"/>	2468	JAY J2 Deep Contour 16" x 18"
<input type="checkbox"/>	2460	JAY J2 Deep Contour 16" x 20"
<input type="checkbox"/>	2477	JAY J2 Deep Contour 17" x 17"
<input type="checkbox"/>	2486	JAY J2 Deep Contour 18" x 16"
<input type="checkbox"/>	2488	JAY J2 Deep Contour 18" x 18"
<input type="checkbox"/>	2480	JAY J2 Deep Contour 18" x 20"
<input type="checkbox"/>	2408	JAY J2 Deep Contour 20" x 18"
<input type="checkbox"/>	2400-MJ	JAY J2 Deep Contour 20" x 20"
<input type="checkbox"/>	2428	JAY J2 Deep Contour 22" x 18"

JAY Fusion Cushion w/ ROHO Dual Valve Air Insert		
<input type="checkbox"/>	JFUSION1416AD	JAY Fusion 14" x 16"
<input type="checkbox"/>	JFUSION1616AD	JAY Fusion 16" x 16"
<input type="checkbox"/>	JFUSION1618AD	JAY Fusion 16" x 18"
<input type="checkbox"/>	JFUSION1620AD	JAY Fusion 16" x 20"
<input type="checkbox"/>	JFUSION1717AD	JAY Fusion 17" x 17"
<input type="checkbox"/>	JFUSION1816AD	JAY Fusion 18" x 16"
<input type="checkbox"/>	JFUSION1818AD	JAY Fusion 18" x 18"
<input type="checkbox"/>	JFUSION1820AD	JAY Fusion 18" x 20"
<input type="checkbox"/>	JFUSION2018AD	JAY Fusion 20" x 18"
<input type="checkbox"/>	JFUSION2020AD	JAY Fusion 20" x 20"
<input type="checkbox"/>	JFUSION2220AD	JAY Fusion 22" x 20"

JAY X2 Cushion		
<input type="checkbox"/>	JX21416	JAY X2 14" x 16"
<input type="checkbox"/>	JX21616	JAY X2 16" x 16"
<input type="checkbox"/>	JX21618	JAY X2 16" x 18"
<input type="checkbox"/>	JX21620	JAY X2 16" x 20"
<input type="checkbox"/>	JX21717	JAY X2 17" x 17"
<input type="checkbox"/>	JX21816	JAY X2 18" x 16"
<input type="checkbox"/>	JX21818	JAY X2 18" x 18"
<input type="checkbox"/>	JX21820	JAY X2 18" x 20"
<input type="checkbox"/>	JX22020	JAY X2 20" x 20"

JAY Union Cushion		
<input type="checkbox"/>	JU1416	JAY UNION 14" x 16"
<input type="checkbox"/>	JU1616	JAY UNION 16" x 16"
<input type="checkbox"/>	JU1618	JAY UNION 16" x 18"
<input type="checkbox"/>	JU1620	JAY UNION 16" x 20"
<input type="checkbox"/>	JU1717	JAY UNION 17" x 17"
<input type="checkbox"/>	JU1816	JAY UNION 18" x 16"
<input type="checkbox"/>	JU1818	JAY UNION 18" x 18"
<input type="checkbox"/>	JU1820	JAY UNION 18" x 20"
<input type="checkbox"/>	JU2018	JAY UNION 20" x 18"
<input type="checkbox"/>	JU2020	JAY UNION 20" x 20"
<input type="checkbox"/>	JU2220	JAY UNION 22" x 20"

JAY Ion Cushion		
<input type="checkbox"/>	JION1416	JAY ION 14" x 16"
<input type="checkbox"/>	JION1616	JAY ION 16" x 16"
<input type="checkbox"/>	JION1618	JAY ION 16" x 18"
<input type="checkbox"/>	JION1620	JAY ION 16" x 20"
<input type="checkbox"/>	JION1717	JAY ION 17" x 17"
<input type="checkbox"/>	JION1816	JAY ION 18" x 16"
<input type="checkbox"/>	JION1818	JAY ION 18" x 18"
<input type="checkbox"/>	JION1820	JAY ION 18" x 20"
<input type="checkbox"/>	JION2018	JAY ION 20" x 18"
<input type="checkbox"/>	JION2020	JAY ION 20" x 20"
<input type="checkbox"/>	JION2220	JAY ION 22" x 20"

JAY Union Reduced Profile Cushion		
<input type="checkbox"/>	JU1416RP	JAY Union RP 14" x 16"
<input type="checkbox"/>	JU1616RP	JAY Union RP 16" x 16"
<input type="checkbox"/>	JU1618RP	JAY Union RP 16" x 18"
<input type="checkbox"/>	JU1620RP	JAY Union RP 16" x 20"
<input type="checkbox"/>	JU1717RP	JAY Union RP 17" x 17"

<input type="checkbox"/>	JU1816RP	JAY Union RP 18" x 16"
<input type="checkbox"/>	JU1818RP	JAY Union RP 18" x 18"
<input type="checkbox"/>	JU1820RP	JAY Union RP 18" x 20"
<input type="checkbox"/>	JU2018RP	JAY Union RP 20" x 18"
<input type="checkbox"/>	JU2020RP	JAY Union RP 20" x 20"